

Cora

400732



Faretto incasso in gesso



GU10 Max 50W

Dati generali

Product overview

Nome prodotto/Product name	CORA
Codice prodotto/Product code	400732
Materiale/Housing material	Gesso
Colore/Colour	Bianco
Ambiente di utilizzo/Environment	Interno
Certificazione/Certifications	CE
Lumen/Lumen	---
Efficacia luminosa/Luminaire efficacy (lm/W)	---
Gradi Kelvin/Kelvin degrade (K)	---
Angolo/Beam angle	---
Consumo/Power	---
Tensione/Voltage	220-240V 50/60Hz
Classe sicurezza/Isolation class	II Classe
Classe protezione/Protection degree	IP 20
Classe energetica/Energy label	--
Dimensioni articolo/ Carton product	12,0x12,0x5,5(cm)
Dimensioni scatola singolo/Gift box	14,5x9,5x14,5(cm)
Dimensioni cartone/ Carton dimensions	40,x51,0x44,0(cm)
Imballo/Packing	30

Scheda Tecnica - Technical Sheet

Cora

400732



Packaging

Scatolo con stampa
in quadricromia

Giftbox 4 colours

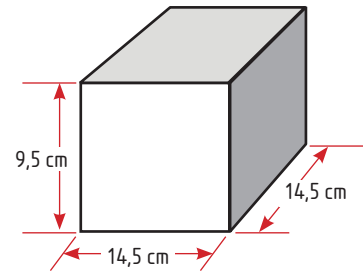

CONFEZIONE SINGOLA
Giftbox

Export carton

Bar code:
Position 4 sides
in the upper left

400732



8 033726 886965



P/I NO.:
LOT NO.: 1725-58-21
CTN NO.:
MADE IN P.R.C.
ITEM NO.: 400732

Lateral sides
Shipping mark:



Importato da: Poliplast srl
via Oliveto Scammacca 7/c
95127 Catania (CT)



8 033726 886965

CORA 400732 220-240V~ GU10

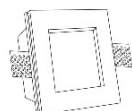

QTY:	30	PCS
G.W.:		Kg
N.W.:		Kg
MEAS:		CM

CORA 400732

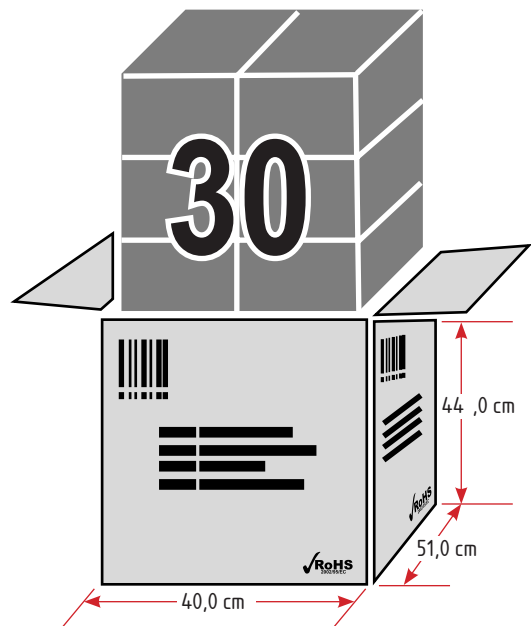

Dettagli Tecnici

Dimensioni
Dimensions

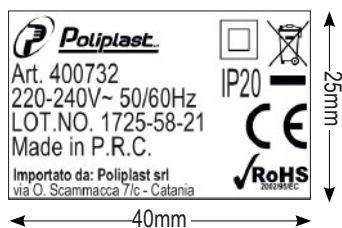
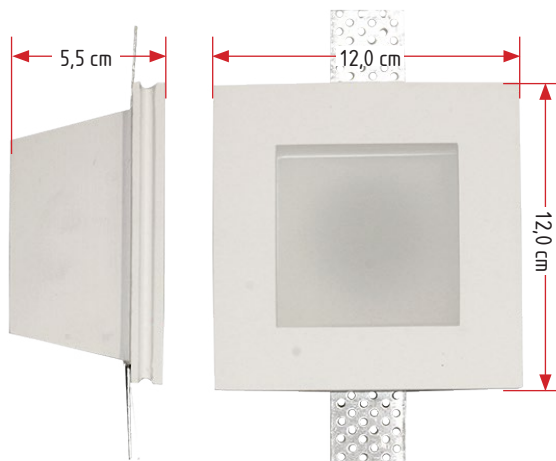

Scheda Tecnica - Technical Sheet

Cora

400732



Staffe di fissaggio
Brackets

Corpo in gesso
Gypsum body



Portalampane GU10
GU Lamp holder

Vetro di protezione
Protection glass

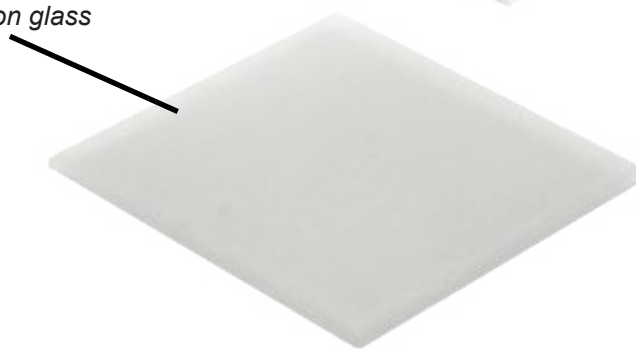

Molla di ritegno lampada
Spring for lamp

Foro per incasso

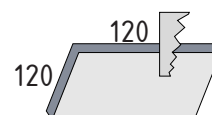

Scheda Tecnica - Technical Sheet

Cora

400732



DICHIARAZIONE DI CONFORMITÀ

La Ditta:

Poliplast S.r.l.
Via Oliveto Scammacca 7
95127 Catania

Dichiara sotto la propria responsabilità che i prodotti contrassegnati con i codici:

400732

al quale questa dichiarazione si riferisce è conforme alle seguenti norme:

- NORMA EN-60838-1:2009-05
- NORMA EN-60838-1:2004+A1:2008-09

E quindi rispondente ai requisiti essenziali delle direttive 2006/95/CE e EMC 2004/108/CE

Catania, 10/10/2014



MANUALE DI ISTRUZIONE LAMPADA INCASSO GESSO 400732

Nota: leggere attentamente le istruzioni prima di installare l'articolo.

400732		GU10	7W LED Max 10W	CLASSE II	FORO INCASSO 125x125 mm	Dimens. 120x120x60 mm
--------	---	------	-------------------	-----------	-------------------------------	--------------------------

CODICE PRODOTTO	EAN	Questo prodotto può contenere sorgenti luminose di classe efficienza energetica fino a:
400732	80337268869995	F

IMPORTANTE: L'installazione o qualsiasi operazione di manutenzione devono essere eseguite a corrente elettrica disconnessa.

CARATTERISTICHE:

Il corpo lampada è costituito da materiale in gesso bianco.
Può essere usato per decorazioni interne, giardini ed altro.

INSTALLAZIONE:

Assicurarsi che la corrente sia disconnessa.
Seguire i passi raffigurati sotto
L'apparecchiatura è doppiamente isolata e quindi non necessita messa a terra.

